

# **RONGTA** USER MANUAL

---

---

## **THERMAL TRANSFER BARCODE PRINTER RPF412**

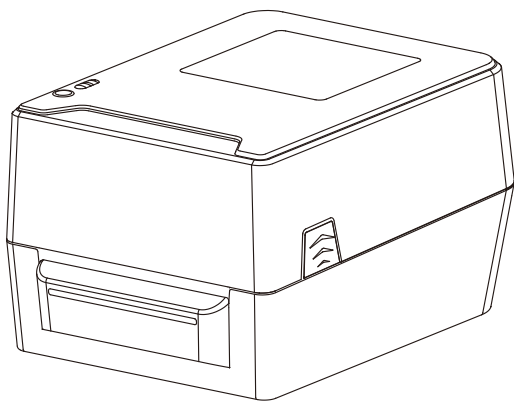

# Contents

---

---

I. Product Introduction .....	2
1.1 Safety Warnings .....	2
1.2 Main Features .....	2
II. Safety Instructions .....	3
III. Appearance and Components .....	4
IV. Technical Parameters .....	5
4.1 Printing Parameters .....	5
4.2 Printer Indicators .....	6
4.3 Printer Interfaces .....	6
V. Installation and Operation of Printer .....	7
5.1 Printer Unpacking .....	7
5.2 Connecting the Printer .....	8
5.3 Ribbon Loading path .....	8
5.4 Paper Loading .....	9
VI. Functions of Printer LED Indicator and button .....	10
6.1 Power-on Functions .....	10
6.2 General Button Functions .....	10
6.3 LED Indicator .....	11
6.4 Ribbon Detection .....	11
6.5 Print self-test Page .....	11
6.6 Initialization of Printer .....	12
6.7 Special Functions of Printer .....	12
VII. Serial Interfaces of Printers .....	14
VIII. Ethernet Interfaces of Printers .....	15
IX. Cleaning the Printer .....	16
9.1 Cleaning the Printer Head .....	16
9.2 Cleaning the Sensor .....	16
9.3 Cleaning the Printing Rubber Roller .....	17
X. Troubleshooting .....	18
10.1 FAQ .....	18
XI. Driver Installation .....	20
11.1 Installation for Windows .....	20
11.2 The Port direct Drive .....	20

# I. Product Introduction



---

---

Thank you for purchasing the thermal transfer barcode/label printer produced by Rongta. This series of machines are equipped with two sets of gear structure driven by a single motor. They can handle 300-meter ribbons and use with large-capacity label paper. If the internal 5"OD (outer diameter) paper capacity is not enough, you just need to purchase an external paper roll holder, so that the printer will support the industry standard 8.4"OD (outer diameter) paper capacity. The printer can meet the needs of real-time and batch printing of labels, and is connected to other equipment through standard serial interfaces, parallel interfaces, USB interfaces and network ports. It provides thermal or thermal transfer printing methods. The printer can support a wide range of printing paper types and a variety of printing materials, including paper rolls, thermal paper and folded label paper. In addition, other commonly used barcodes can be used.

Many common 1D barcodes and QR codes are built into this model. It supports 4 different printing directions. With the zoom function, the font can be zoomed in 1-10 times. In addition to scalable fonts, there are also five different sizes of bitmap fonts in OCR-A and OCR-B fonts. By integrating powerful functions, reasonable prices, and excellent printing.

## 1.1 Safety Warnings

-  **Warning:** Do not touch the paper cutting knife or paper-tearing knife of the printer.
-  **Warning:** The print head is a heating component. Do not touch the print head and its surrounding components when the printer is still warm in temperature.
-  **Warning:** Do not touch the surface of the thermal print head and connectors, to avoid electrostatic damage to the print head.

## 1.2 Main Features

- Optional yes/no to support RFID function;
- Support thermal/thermal transfer printing mode;
- Resolution: 203dpi/300dpi optional;
- Printing speed: 8 ips (203 mm/s)/6 ips (153 mm/s) optional;
- Rich interfaces, USB port + network port, optional WiFi/Bluetooth/NFC;
- The printer with RFID function supports printing and RFID reading and writing at the same time, only printing or only RFID reading and writing;
- It supports the printing of ordinary labels and receipts, and the printer with RFID function also supports the printing of anti-metal interference labels and anti-counterfeiting labels;
- The software supports Bartender, and the print instructions are compatible with Zebra ZPL® commands;
- Comes with editing software, built-in driver, supports automatic installation;

## II. Safety Instructions

---

---

**Before operating and using the printer, please carefully read the following items and strictly observe the use rules.**

- ① Please install the printer on a stable surface to avoid printer suffered from any vibration and shocks.
- ② Do not use and store the printer in places with high temperature, high humidity and high pollution.
- ③ Connect the printer's power adapter to an appropriate grounding socket. Avoid using the same socket with large motors or other equipment that may cause voltage fluctuation of power supply.
- ④ Keep water or conductive materials (such as metal) out of the printer. Once it occurs, Power should be turned off immediately.
- ⑤ Never use the printer without paper, otherwise it will seriously damage the printing rubber roller and thermal head.
- ⑥ Unplug the product from the power outlet if the printer is idle for a long time.
- ⑦ Do not disassemble or modify the product personally.
- ⑧ Use only the power adapter specified in this instruction.
- ⑨ In order to ensure the printing quality and prolong the service life of the product, it is recommended to use the recommended or equivalent thermal printing paper.
- ⑩ Do not plug/unplug the product with the product powered on.
- ⑪ When plugging and unplugging the printer power cord, please hold the arrow position of the printer power connector with your hand, not the cord of the printer power cord.
- ⑫ Please keep this manual for the future use and reference.



# III. Appearance and Components

## □ Front View

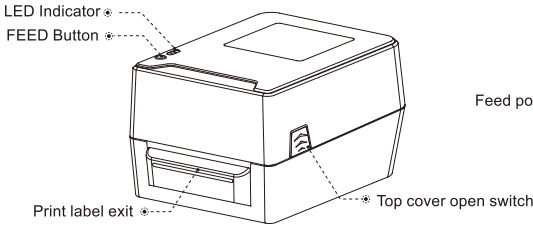

## □ Rear View

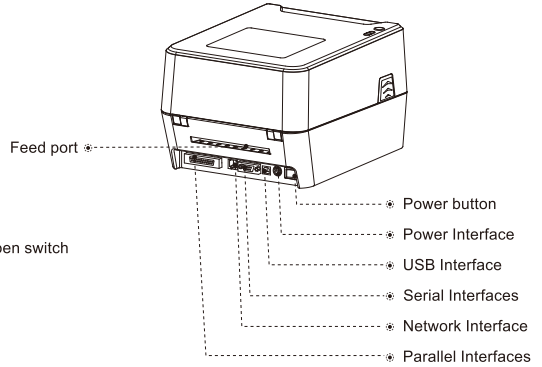

## □ Inside View

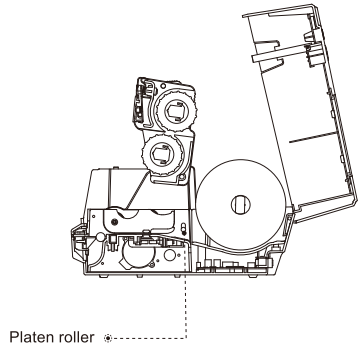
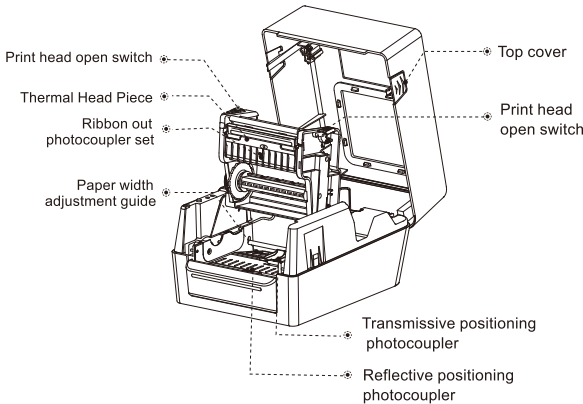

⚠ Caution:  
As Photos, printer transmission interface will vary according to the difference of your purchased printer's type, the actual transmission interface, please refer to the corresponding product specifications

## Application Field

- Manufacturing
- Warehouse logistics industry
- Retail industry
- Parcel post
- Small office and studio
- Medical industry

# IV. Technical Parameters

## 4.1 Printing Parameters

Model	RPF412
Printing method	Thermal line printer
Printing speed	2~5inch/s
Printing paper width	104mm (Max)
printing length (label)	250mm (Max)
Print head dpi	203 DPI or 300DPI
Impulse excitation	1×10 <sup>8</sup> pulses
Thermal piece (wear resistance)	50 KM(Label paper) 150KM(continuous paper)
Ribbon outer diameter	Max 67mm
Ribbon length	300M
Ribbon axis size	1 inch(25.4mm)
Character size	ASCII Font A:12×24 ASCII Font B:9×17 Chinese character 24×24
Ribbon winding form	Roll-out
Maximum outer diameter of inter paper roll	127mm(5")OD
Paper type	Continuous paper, gap paper, Folded paper, black label paper
Paper winding form	Print side roll-out/Print side roll-in
Ribbon width	Min30mm Max110mm
Paper width (label + backing paper)	Min20mm Max118mm
Paper thickness (label + backing paper)	Min0.06mm Max0.254mm
Paper axis size	25.4mm ~38mm
<b>Print character</b>	
ASCII character set	12x24 dot, 1.25 (width)X3.00 (height)mm
National Standard	
Class I and II Chinese Character Font	24x24 dot, 3.00 (width)X3.00 (height)mm
Type of bar code	One-dimensional code: Code 39、39C、I25、Code 93、ITF25、EAN128、Code 128、Codabar、EAN-8、EAN8+2、EAN8+5、EAN-13、EAN13+2、EAN13+5、UPC-A、UPCA+2、UPCA+5、UPC-E、UPCE+2、UPCE+5 MSIC、ITF14、EAN14、CODE11、POST QR code: QRCODE、PDF417(optional)
Extended character table	Cp437, Cp850, Cp852, Cp860, Cp863, Cp865, CP866, WPC1250, WPC1251, WPC1252, WPC1253, WPC1254
<b>Power supply</b>	
Input power supply	AC 100 ~ 240V
Output power	DC 24V 2.5A
<b>Environmental requirements</b>	
Working environment	Built-in voltage automatic switching power supply
Storage environment	Operating temperature: 0~45°C, operating humidity: 20~90% Storage temperature: -10~60°C, storage humidity: 10~90%
<b>Environmental conditions</b>	
Print command	TSPL/CPCL(Customizable)/ZPL(Customizable)

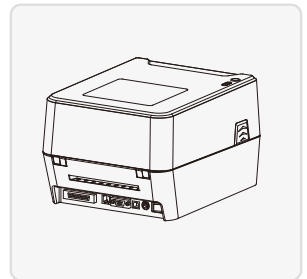
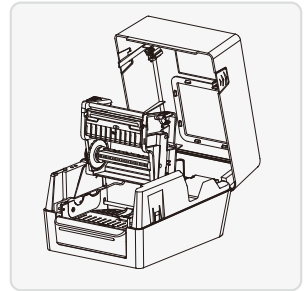



☐ The pictures are for reference only, please subject to practicality.

## 4.2 Printer Indicators

<b>Type of printing paper</b> Thermal paper rolls recommended	Continuous paper, label paper, Folded paper, black label paper
	<p><b>⚠ Attention</b></p> <p>(1) To get the best results from the printer, choose the recommended paper or other paper with equivalent quality, otherwise the printing quality will be affected and even the service life of thermal print head will be reduced.</p> <p>(2) Please do not use the paper roll that the end glued on the core of the paper roll, otherwise it may cause damage to the printer.</p> <p>(3) If the printing paper is contaminated by chemicals or oils, it may fade or reduce the sensible heat degree, and affect the printing effect.</p> <p>(4) Do not rub the surface of the printing paper with hard articles, otherwise it may cause fading.</p> <p>(5) The print paper will fade if the temperature is up to 70°C, keep it out of direct sunlight, humidity and high temperature.</p>

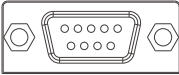
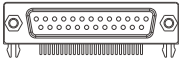
## 4.3 Printer Interfaces

Diagram	Type	Illustration
	USB	Universal USB Interface (Standard Type B)
	Serial interface	Db9 female connector interface, communication baud rate is 9600bps, 38400bps, 19200bps or 115200bps optional (adjusting via DIP switch), data structure is parity-free, 8-bit data bit, 1-bit stop bit; RTS/CTS and XON/XOFF handshake protocols are supported
	Parallel interface (25PIN)	25PIN Parallel (male connector) bidirectional parallel interface, 8-bit parallel interface, support BUSY/nAck handshake protocol 8
	Network interface	Standard RJ45-8P interface, 10M/100M transmission speed with self-adaptation, 100M network LED indication, data communication LED indication.
	Power interface	Power plug DC 24V.

⊖ **Note:** The interface is optional or customized, and the specific interface is subject to the actual object.







# V. Installation and Operation of Printer

## 5.1 Printer Unpacking

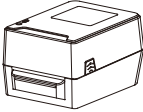
### Check the parts:

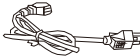
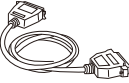
Before use, make sure the accessories are included in the package(the following picture is an example). If any thing is missing, contact the supplier or manufacturer. The specific accessories may not be included depending on the printer model.

### ■ Standard accessories

 Main machine	 Power adapter	 Power cord	 Serial cable
 Ribbon+Paper core	 USB cable	 Quick Installation guide	 Parallel cable

### ■ Optional

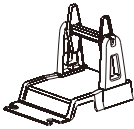
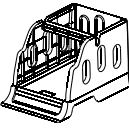
 External bracket A	 External bracket B
--	--

☺ The pictures are for reference only, please subject to practicality.

## 5.2 Connecting the Printer

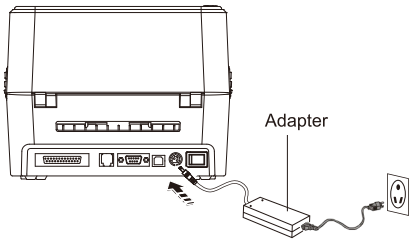

1. Place the printer on a stable surface.
2. Confirm that the power is off.
3. Insert one end of the serial cable or USB cable into the socket at the back of the printer, and then insert the other end of the cable into the appropriate port of the computer.
4. Plug the power line into the power socket at the back of the printer and plug the other end into the AC socket.

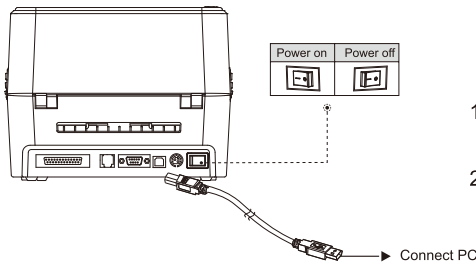

### ⚠ ATTENTION:

1. Please turn off the printer and plug the power line into the power socket of the printer.
2. The transmission interface of the printer in the picture will vary depending on the model you purchased. For the actual transmission interface, please refer to the specifications of the corresponding product model you bought.

## 5.3 Ribbon Loading Path

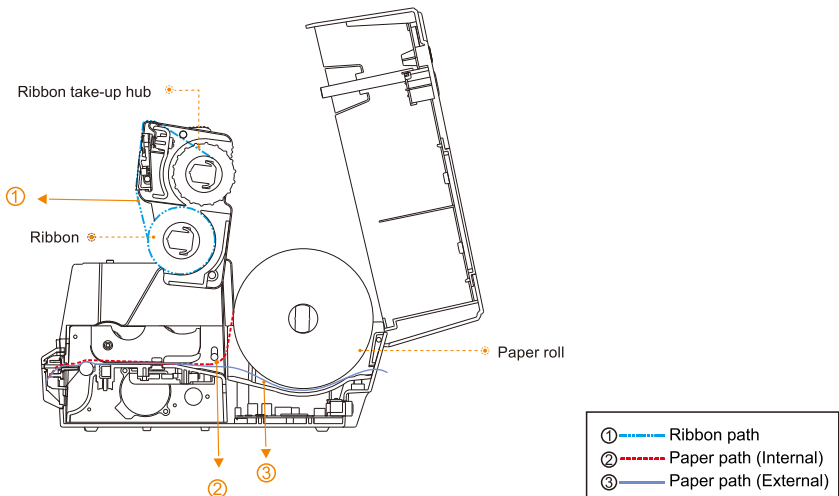

## 5.4 Paper Loading

1. Press the switch on the left and right sides of the top cover with both hands to open the top cover of the printer.
2. Load the paper roll on the label supply shaft and fix the paper roll in the center of the supply shaft with stop block. (If a 4" paper roll is used, you can remove the stop block and just use the paper shaft.)
3. Press the print head switch to open the print head. Pull out the front end of paper (keep print face upward), and send it across the platen roller, paper width adjustment guide and transmissive positioning photocoupler set, and adjust the paper to the appropriate position.
4. Close the print head. Make sure the print head is completely closed to ensure print quality.

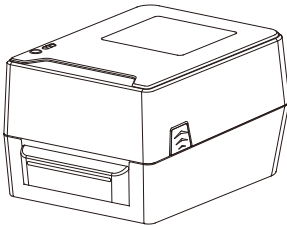

1

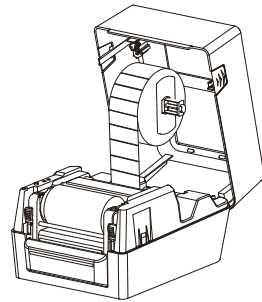

2

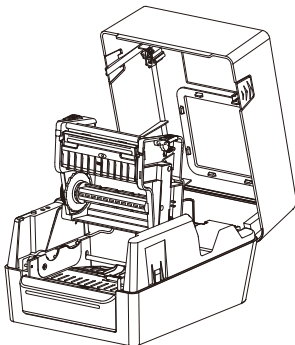

3

4

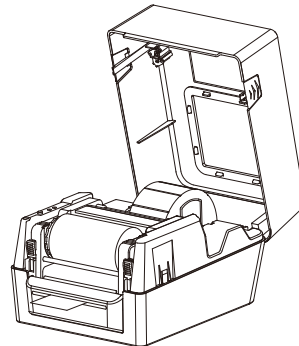

## VI. Functions of printer LED indicator and button

The printer has 1 button and 1 indicator. Pressing the button or together with the power switch according to the indicator of different states can enable the printer to activate multiple functions, such as feeding paper, pausing printer actions, printing self-test page, printer initialization, etc. See below for details.

### 6.1 Power-on Functions

The printer has three power-on functions to set up or test the hardware. Press and release the button while powering on the printer to activate these functions.

**Please follow the steps below to activate the power-on functions**

Function	Description
Power-on self-test	A. Turn off the printer B. Make sure the printer is loaded with paper. Press and hold the FEED button while turning on the printer, and the printer will print a self-test page; then release the FEED button.
Printer initialization	A. Turn off the printer B. Open the top cover of print head, press and hold the FEED button, turn on the printer, and press and hold FEED button for 10s. Then the printer will clear the downloaded data from the internal memory (DRAM) and restore the parameters to the factory settings.
Ribbon detection and auto positioning	When the printer is on or powered on, after replacing paper and closing the top cover of printer, the printer will automatically detect the ribbon status and perform auto positioning.

### 6.2 General Button Functions

#### 1. Feed

When the printer is ready (LED is blue), press the button and the label paper will be fed to the front end of next label paper.

#### 2. Pause printing

When the printer is working, press FEED button to pause; press the button again to resume printing.

### 6.3 LED Indicator

The indicators indicate the current status of the printer, and the buzzer indicates changes in the printer's status.

LED Indicators status	Buzzer status description	Description
The indicator flashes twice continuously	The buzzer beeps twice continuously	Printer mechanism error
The indicator flashes 3 times continuously	The buzzer beeps 3 times continuously	Paper shortage error
The indicator flashes 5 times continuously	The buzzer beeps 5 times continuously	Overheating error
The indicator flashes 6 times continuously	The buzzer beeps 6 times continuously	Cover opening error
The indicator flashes 7 times continuously	The buzzer beeps 7 times continuously	Seam label error
The indicator flashes 9 times continuously	The buzzer beeps 9 times continuously	No SDRAM detected
The indicator flashes 10 times continuously	The buzzer beeps 10 times continuously	No serial FLASH detected
The indicator flashes 11 times continuously	The buzzer beeps 11 times continuously	Ribbon error

### 6.4 Ribbon Detection

This setting is used to determine whether the ribbon is loaded, used up or whether it works properly. This function is valid only after thermal transfer function is enabled.

### 6.5 Print Self-Test Page

This function is used to print the internal parameters of the machine after the printer is turned on, to check the setting parameters and determine whether the machine is normal or not.

1. Please make sure the label paper is properly loaded
2. Turn off the printer
3. Press and hold the FEED button while turning on the printer.
4. Release the FEED button when the printer feeds paper and prints content.
5. The printed content is self-test page style.

#### Self-test page style

whether the printer works normally. The printed self-test values can be used to check the print quality of the print head and learn about the setting status of the printer.



## 6.6 Initialization of Printer

The printer initialization function is to clear the downloaded data from the memory (DRAM) and restores the parameters to the factory settings. Please follow the steps below to initialize the printer:

1. Turn off the power.
2. Open the top cover of print head, press and hold the FEED button of the printer, turn on the printer, and press and hold FEED button for 10s.
3. When all indicators of the printer are off, release the FEED button and the printer will re-start. At this point, the printer has been initialized.

## 6.7 Special Functions of Printer

### WIFI function (alternative)

WiFi is a technology that allows electronic devices to connect to a WLAN. Currently, the company's printers use 2.4G RF frequency band. There is a password for protection for the connection to WLAN; However, it can also be public, thus allowing any device within WLAN range to be connected. For specific WIFI setting steps, please refer to the "WIFI" setting in the integrated tool setting manual.

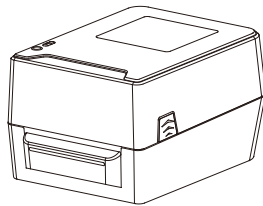

## Bluetooth function (alternative)

Bluetooth is a radio technology that supports short-distance communication of equipment (generally within 10m). It can conduct wireless information exchange among many devices including mobile phones, PDA, wireless headphones, notebook computers, related peripherals, etc. The Bluetooth standard is IEEE802.15, which works in the 2.4GHz band, and the bandwidth is 1 MB/s.

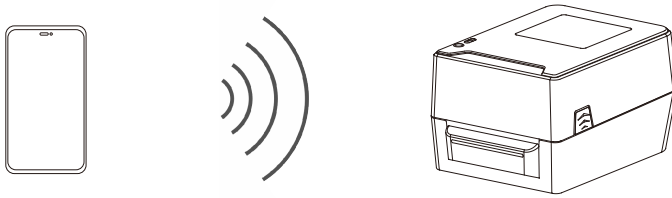

## USB functions

USB cable is an optional accessory of the printer, which is used to connect the printer to a PC set parameters, and transmit data, etc.

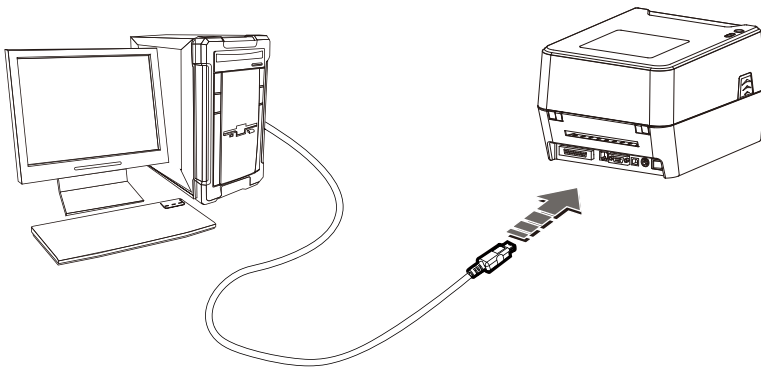

## VII. Serial Interfaces of Printers

The serial interface of thermal transfer barcode printer adopts RS-232 standard. The communication baud rate is 9600bps, 19200bps, 38400bps or 115200bps optional (adjusting via DIP switch). It is parity-free, 8-bit data bit, 1-bit stop bit; RTS/CTS and XON/XOFF handshake protocols are supported.

**The functions of each pin of the printer serial interface are defined as follows:**

Pin number	Model	Signal source	Description
2	TXD	Printer	The printer sends data to the host.
3	RXD	Host	The printer receives data from the host.
8	RTS	Printer	This signal reflects the current status of printer. A high electrical level indicates that the printer is "busy" and cannot receive data, while a low electrical level indicates that the printer is "ready" and can receive data.
5	GND	-----	Signal ground
6	DTR	Printer	Same as RTS signal (pin 8).

**Schematic diagram of connection between printer serial interface and POS host serial interface:**

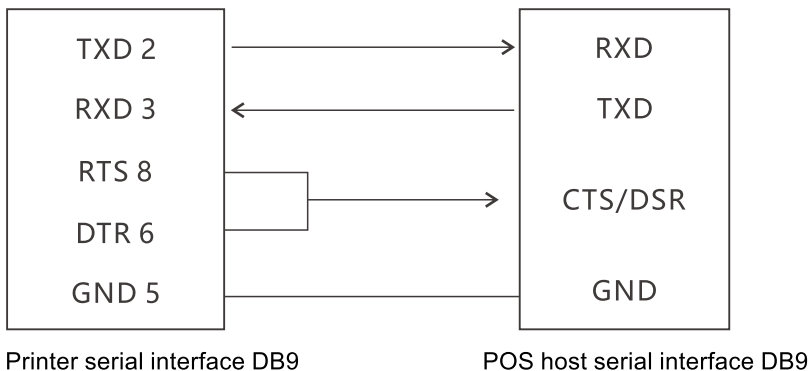

## VIII. Ethernet Interfaces of Printers

---

---

The Ethernet interface socket of thermal transfer barcode printer is standard RJ45-8P, it supports 10M/100M network, and the transmission speed is adaptive.

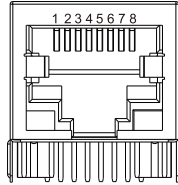

Pin number	Description	Illustration
1	TX+	Send differential line+
2	TX-	Send differential line-
3	RX+	Receive differential line+
4	NC	No function
5	NC	No function
6	RX-	Receive differential line-
7	NC	No function
8	NC	No function

## IX. Cleaning the Printer

---

### 9.1 Cleaning the Printer Head

**Clean the print head when one of the following conditions occurs to the printer:**

- (1) Printing is not clear;
- (2) A vertical column of the printed page is not clear;
- (3) The paper feeding noise is high.

**The print head cleaning steps are as follows:**

- (1) Turn off the power supply of the printer, open the upper cover and remove the paper if exists.
- (2) If printing has just been completed, wait for the print head to cool completely;
- (3) Clean the printer head with a soft cotton moistened with ethyl alcohol.
- (4) After waiting for absolute ethyl alcohol to volatilize completely, close the upper cover and try printing again.

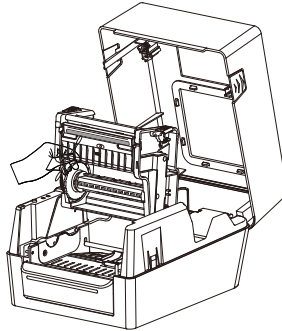

### 9.2 Cleaning the Sensor

**Clean the paper shortage sensor when one of the following conditions occurs to the printer:**

- (1) In the printing process, the printer occasionally stops printing and alarms for paper shortage;
- (2) No alarm for paper shortage.

**The paper shortage sensor cleaning steps are as follows:**

- (1) Turn off the power supply of the printer, open the upper cover, and remove the paper if there is any;
- (2) Wipe off the dust and stain on the sensor surface with soft cotton cloth (which should be dried) dipped in absolute ethyl alcohol.
- (3) After waiting for absolute ethyl alcohol to volatilize completely, close the upper cover and try to start the machine again.

### 9.3 Cleaning the Printing Rubber Roller

**When one of the following conditions occurs to the printer, the printing rubber roller should be cleaned:**

- (1) Printing is not clear;
- (2) A vertical column of the printed page is not clear;
- (3) The paper feeding noise is high.

**The printing Rubber Rollers cleaning steps are as follows:**

- (1) Turn off the power of the printer and open the upper cover;
- (2) Use a soft cotton cloth (which should be dried) dipped in a neutral detergent to wipe off dust and stains on the surface of the printing rubber roller;
- (3) Close the upper cover after the cleaning agent is completely volatilized.

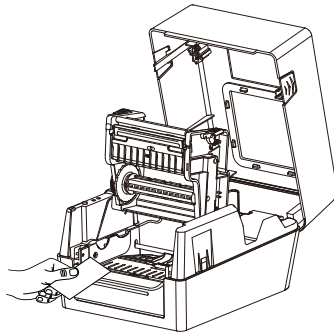

#### **⚠ Attention:**

- (1) The power supply must be turned off during the daily maintenance of the printer.
- (2) Do not touch the surface of the print head with hands and metal objects, and do not scratch the surface of the print head, printing rubber roller and sensor with tweezers and other tools.
- (3) The organic solvents such as gasoline and acetone shall not be used.
- (4) Wait until absolute ethyl alcohol is completely volatilized, then turn on the power supply to continue printing.

# X. Troubleshooting

## 10.1 FAQ

The table below shows common problems and solutions for operators.

If you have followed the simple troubleshooting methods but the printer is still not functioning properly, please contact the customer service department of your dealer for assistance.

Fault Phenomenon	Cause	Solution
Incomplete print content	<ul style="list-style-type: none"><li>● The AC plug and the power supply plug are not properly connected to the printer socket</li><li>● The printer power switch is not on</li><li>● Ribbon has been used up</li><li>● Ribbon loading path is incorrect</li><li>● Label paper has been used up</li><li>● Label loading path is incorrect</li><li>● Gap sensor detection is incorrect</li><li>● Label paper may be stuck inside the printer</li></ul>	<ul style="list-style-type: none"><li>● Check the power connection and confirm that the AC plug and the power supply plug are properly connected to the printer socket</li><li>● Turn on the printer</li><li>● Load ribbon</li><li>● Please reload the ribbon according to the ribbon loading steps</li><li>● Load new label paper</li><li>● Please reload the label paper according to the label loading steps</li><li>● Resize and print</li><li>● Clean the mechanism inside</li></ul>
Incorrect positioning	<ul style="list-style-type: none"><li>● Check if the transmission line is properly connected to the printer's transmission interface</li><li>● Pins in the serial cable are not 1 to 1 type</li></ul>	<ul style="list-style-type: none"><li>● Reconnect the transmission line</li><li>● If a serial cable is used,<ul style="list-style-type: none"><li>- Please replace the serial cable and the pins in the cable must be 1 to 1 type</li><li>- Please confirm the transmission rate in the printer. You can confirm the transmission rate of the serial port by printing a self-test page.</li></ul></li><li>● If an Ethernet cable (Ethernet) is used, (Ethernet),<ul style="list-style-type: none"><li>- Please confirm that the Ethernet RJ-45 green/orange indicator is on</li><li>- Please confirm that the printer has obtained an IP address under DHCP mode</li><li>- Please confirm that a correct IP address is set when using a fixed IP</li><li>- Please wait a few seconds for the printer to contact the server, and then confirm the IP address again</li></ul></li><li>● Replace the transmission line</li><li>● The ribbon and label used do not match</li></ul>

Fault Phenomenon	Cause	Solution
Poor print result	<ul style="list-style-type: none"> <li>● Ribbon /Paper loading error</li> <li>● Print head/rubber roller has dust or adhesive accumulation</li> <li>● Print density setting error</li> <li>● print head is damaged</li> <li>● The ribbon and label used do not match</li> </ul>	<ul style="list-style-type: none"> <li>● Reinstall supplies</li> <li>● Clean the print head</li> <li>● Clean the rubber roller</li> <li>● Adjust the print density and print speed</li> <li>● Print the self-test values and check if the print head is damaged. If yes, please replace the print head.</li> <li>● Replace with a proper ribbon or label paper</li> <li>● If the thickness of the label paper exceeds 0.22mm, it may lead to low print quality.</li> <li>● Confirm that the print head holder is completely closed</li> </ul>
Paper skips when printing	<ul style="list-style-type: none"> <li>● Label size setting is incorrect or incomplete</li> <li>● The sensor is not recalibrated after label replacement. The label sensor is covered by dust, causing incorrect detection</li> </ul>	<ul style="list-style-type: none"> <li>● Resize and print</li> <li>● Use an air brush to remove dust from the sensor</li> </ul>
Print contents on the left and right are missing	<ul style="list-style-type: none"> <li>● Label size setting is incorrect</li> </ul>	<ul style="list-style-type: none"> <li>● Set the correct label size</li> </ul>
Wrinkled paper	<ul style="list-style-type: none"> <li>● Uneven pressure of print head</li> <li>● Incorrect loading of ribbon</li> <li>● Incorrect loading of label paper</li> <li>● Incorrect print density</li> <li>● Incorrect feeding of label paper</li> </ul>	<ul style="list-style-type: none"> <li>● Please set the proper label printing density</li> <li>● Please adjust the label width adjuster to fit the label width</li> </ul>
Gray lines appear on black label paper	<ul style="list-style-type: none"> <li>● The print head is dirty</li> </ul>	<ul style="list-style-type: none"> <li>● Clean the print head</li> </ul>
Color lines	<ul style="list-style-type: none"> <li>● The rubber roller is dirty</li> </ul>	<ul style="list-style-type: none"> <li>● Clean the rubber roller</li> </ul>
Printing is unstable	<ul style="list-style-type: none"> <li>● The printer is in Hex Dump mode</li> <li>● Incorrect setting of the serial communication (RS-232)</li> </ul>	<ul style="list-style-type: none"> <li>● Restart the printer to exit Dumpmode</li> <li>● Reset RS-232</li> </ul>



## **XI. Driver Installation**

---

---

There are two ways to drive the thermal transfer barcode printer, one is to install the driver directly under Windows 9X/7/8/10/ME/2000/XP/Linux/MAC, the other is to use the port for direct driving.

### **11.1 Installation for Windows**

Add the printer to Windows and assign the driver files in the driver disk to Windows. You can start printing only by calling the print command in the program. In this way, the printer driver of Windows actually converts characters into graphic dot matrix for printing.

### **11.2 The Port Direct Drive**

In this way, there is no need to use a driver, only the characters need to be directly output to the port, and the built-in and cartridge font inside the printer is used to realize the conversion and printing of the characters. Using the port direct drive way, the printing mode is also changed from page printing mode to line printing mode, making printing control more convenient. If the port direct drive mode is used, the instruction set needs shall be used to control the printing of the printer, specifically supported For the print command set, please refer to the [Printing Parameters] option in the [Print command] on page 5 of this manual.



**Rongta Technology (Xiamen) Group Co., Ltd.**

**ADD: No.88, Tonghui South Road, Tongan, Xiamen, China.**

**WEB: [www.rongtatech.com](http://www.rongtatech.com)**

**TEL: 0086-592-5666129    FAX: 0086-592-5659169**

